



FOCUS
Home Improvements

focushomeimprovements.com.au

Lot 54 Beach Rd, Noarlunga Centre, SA 5168

E: admin@focusnational.com.au

Ph: 1800 818 815

Re-Roofing, Gutters & Gutter Guard

Quality you can trust



The FOCUS Difference

“Your go-to home
improvements company”

Focus Home Improvements is a family-owned and operated business with 35+ years' experience as a leader in home improvements across South Australia, including the Adelaide region.

The Focus difference is that we understand how valuable home improvements are to your family. This is why we strive for 100% customer satisfaction on every project, big or small.

Our trained professionals use locally manufactured products of the highest quality on your home, as if it were our own. But the best part is that we will always offer the best value for your money.

Our Guarantee

you can trust us with your home



Fully insured

For your peace of mind, we carry a \$20m Public Liability Insurance policy.



Professional Service

All trades people are highly trained in their field of expertise and are fully licensed.



Industry Experienced

With 35+ years of industry experience you can rest assured Focus Home Improvements will offer a professional and efficient service.



Family-Owned

We use locally manufactured products of the highest quality on your home with the utmost professional installations, as if it were our own.







Master Builders

We are proud to be a long-standing member of the Master Builders SA Association.

FOCUS Re-Roof

Nothing but the best for your home
as if it were our own

Our Materials

-  A wide variety of **COLOURBOND®** colours that suit any home facade.
-  **BHP Zinalume®** zinc/aluminium alloy coated steel. High tensile 0.42 base metal thickness (BMT) and 0.487 total coated thickness (TCT).
-  **BHP COLOURBOND®** pre-painted **Zinalume®** steel. High tensile 0.442 base metal thickness (BMT) and 0.487 total coated thickness (TCT).
-  **Zinalume®** substrate lasts up to 4 times longer than galvanised iron.





5 Year Warranty

on workmanship

+ 25 Year Warranty

on all BHP products

Our warranties are issued and back by BHP, the Big Australian

FOCUS 3-Step Re-Roof Process



Step 1

All existing purlins are checked for structural integrity

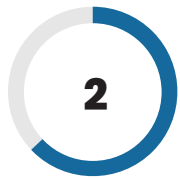

Step 2

New valleys are installed and new roof is laid using colour-matched **Buildex**[®] self-drilling roofing screws



Step 3

New barge caps replace old timber barge caps reducing unnecessary maintenance and painting



Before



After

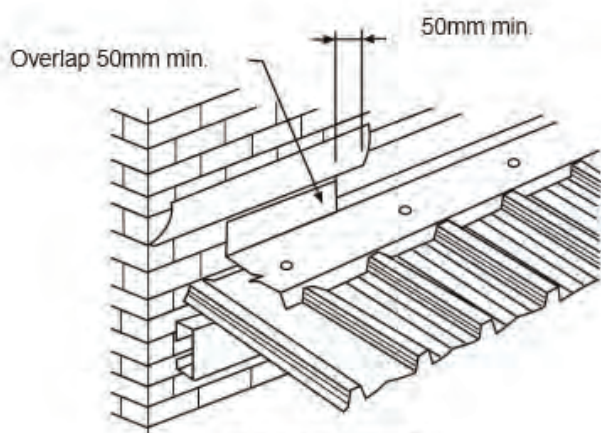

(a) Parapet flashing

Sloped wall flashing, incorporate a 10 mm weathering fold, fixed into a 15 mm deep saw cut

Fasten at 500 mm centres

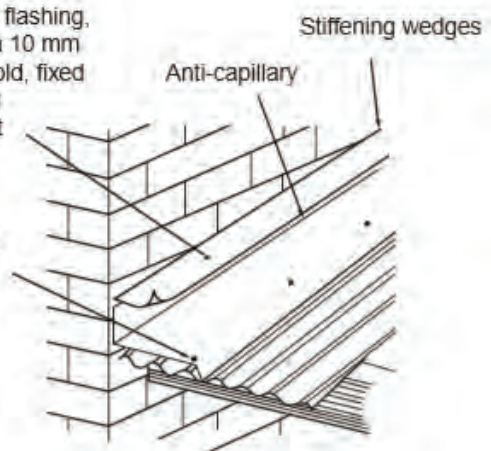

(b) Sloped wall flashing

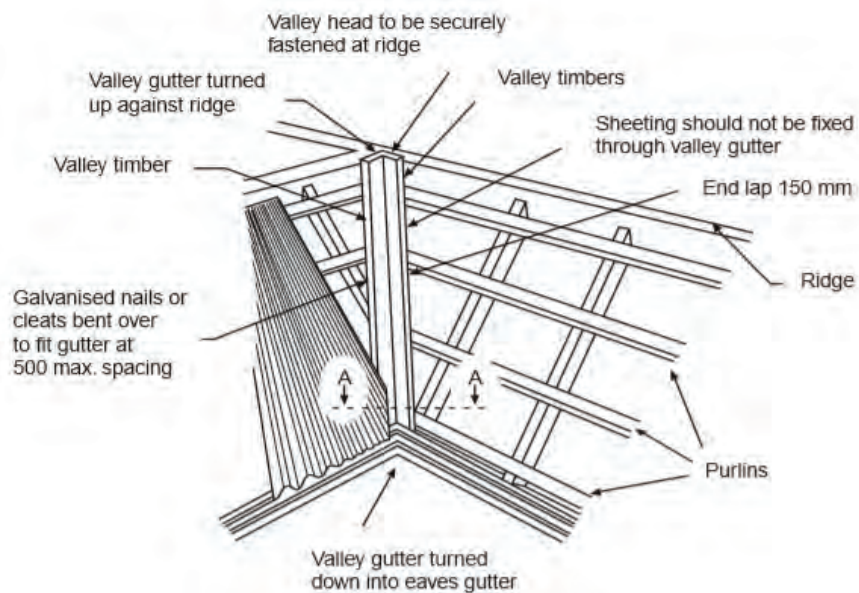

The Specifics

Don't just take our word for it...



My next-door neighbour was so **impressed** with the quality of finish to my roof **he also signed up with Focus to have his roof done.**

Margaret and I were impressed with the standard of their work.

Lindsay & Margaret B.



I would like to thank Focus for bringing our roof back to life. The **service was of a very high standard** from the initial contact right through to the workman who completed the project.

The end result is fantastic and we are very pleased with the professional but friendly attitude of the Focus team.

Barnadette A.



Rest Assured

Australian made
for Australian conditions

Complies with
Australian Standards

Interest free finance
available on all home
improvement services



Quality accredited methods
ensuring you're checked and secure

The Focus Transformation..



Every Season Gutter Guard



No more dreaded and potentially dangerous gutter cleaning.



Stops all types of debris causing blockages that can flood eaves and ceilings plus pose fire hazards.



Extends the life of your gutters saving you cash in the long-run,



Prevents birds and rodents from entering the roof via gutters.



Suitable for all tile, iron and flat roofing plus valleys and box gutters.



Clean tank water, eliminates brown colouring.

A photograph of a family of four in a living room. A man is carrying a young boy on his shoulders, and a woman is sitting on a white bench holding a baby. They are all smiling and playing together. The background features a wood-paneled wall and a white staircase.

**Match your gutter guard
to any COLOURBOND colour**



Our Service

We guarantee your gutters will be 100% free of leaves, sticks, bark and gum nuts for years after fitting.

Our qualified consultants will come to you to provide a free, no-obligation measure, design and quote service.

They can help you with various options, covering supply and fit.

You don't have to do the whole roof!

Our Gutter Guard fitters are trained to clean the gutters, fit the selected mesh according to design and colour plus clean up afterwards.

How it works...

As water flows over the mesh, surface tension draws water from the top V face to the bottom, to fall off the ribs.

In this way, the surface tension effect eliminates “sheeting” of water over the mesh, ideal for rainwater collection!

Inspection Points

To create an emergency access, a small piece of mesh (approx. 100mm x 100mm) is removed at each downpipe.

A larger piece of mesh is then screwed over the cavity to make a simple, easy to use inspection point.

Valleys - (Gullies)

These fill with leaf debris and leak just like gutters, only this time you get the water inside!

A 750mm wide strip of mesh is fitted over the valley from top to bottom. A small bead of silicone is used to seal the mesh against the cap tiles at the top of the valley.

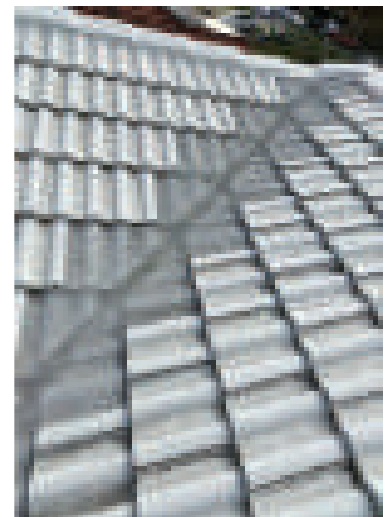
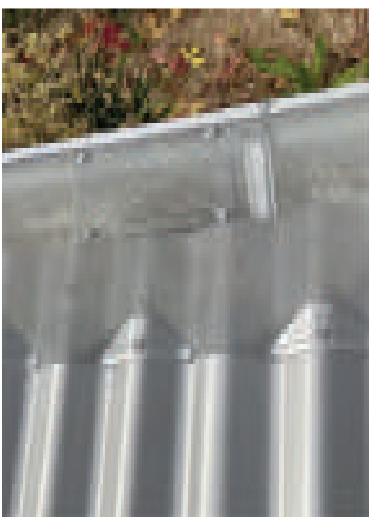

Save Money on Your Home Improvement

You won't believe how easy it is...

Display home sign for 12 weeks

We offer homeowners who have a complete job with Focus the opportunity to save substantial cash on their home improvement.

That's right! We'll cover a portion of the cost on us!

What do you have to do? All we ask is for your permission to display our signage at the front of your home for 12 weeks... that's it!

Do you have any of these? **What we look for...**

- | | | |
|----------------------------------|---|--|
| <input type="checkbox"/> Shops | <input type="checkbox"/> Sports Grounds | <input type="checkbox"/> Parks & Dog Parks |
| <input type="checkbox"/> Schools | <input type="checkbox"/> Walking Trails | <input type="checkbox"/> High Volume Traffic |





Finance

Payment Plans

We've partnered with **Our Money Market** and **Humm** because we want you to be able to make your house a home with ease and without financial restrictions or stress.

Our Money Market

- ✓ Same day, no-obligation approvals
- ✓ Repayments scheduled weekly, fortnightly or monthly
- ✓ Borrow \$5,000 - \$35,000 with up to 84 months to pay
- ✓ Low fixed interest and no hidden fees after establishment

Humm

- ✓ Fast approval and add-ons available
- ✓ Interest free forever weekly or fortnightly repayments
- ✓ Borrow up to \$20,000 with 12 - 50 months to pay
- ✓ Fees may apply

3 EASY STEPS

1

Apply Online

Via the Focus Home Improvements website in the 'finance' tab.

2

Approval

Once approved, **Our Money Market** or **Humm** pays the costs of your products directly to Focus for you.

3

Repayments

Repayments are conveniently scheduled with your income.



Address

Colonnades Shopping Centre, Shop SPI95 (Between Big W & Woolworths)
Lot 54 Beach Rd, Noarlunga Centre SA 5168



Open Hours

Mon - Fri	9:00 am - 5:30 pm
Thurs	9:00 am - 7:00 pm
Sat	9:00 am - 5:00 pm
Sun	Closed



Follow us for home inspo!

